

INSTALLATION MANUAL

10115T

ecodownlight

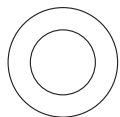

160mm

230V | SMD 2835 | 15W | IP20 | Aluminium

Complete with driver.

80 CRI



43mm

one
LIGHT

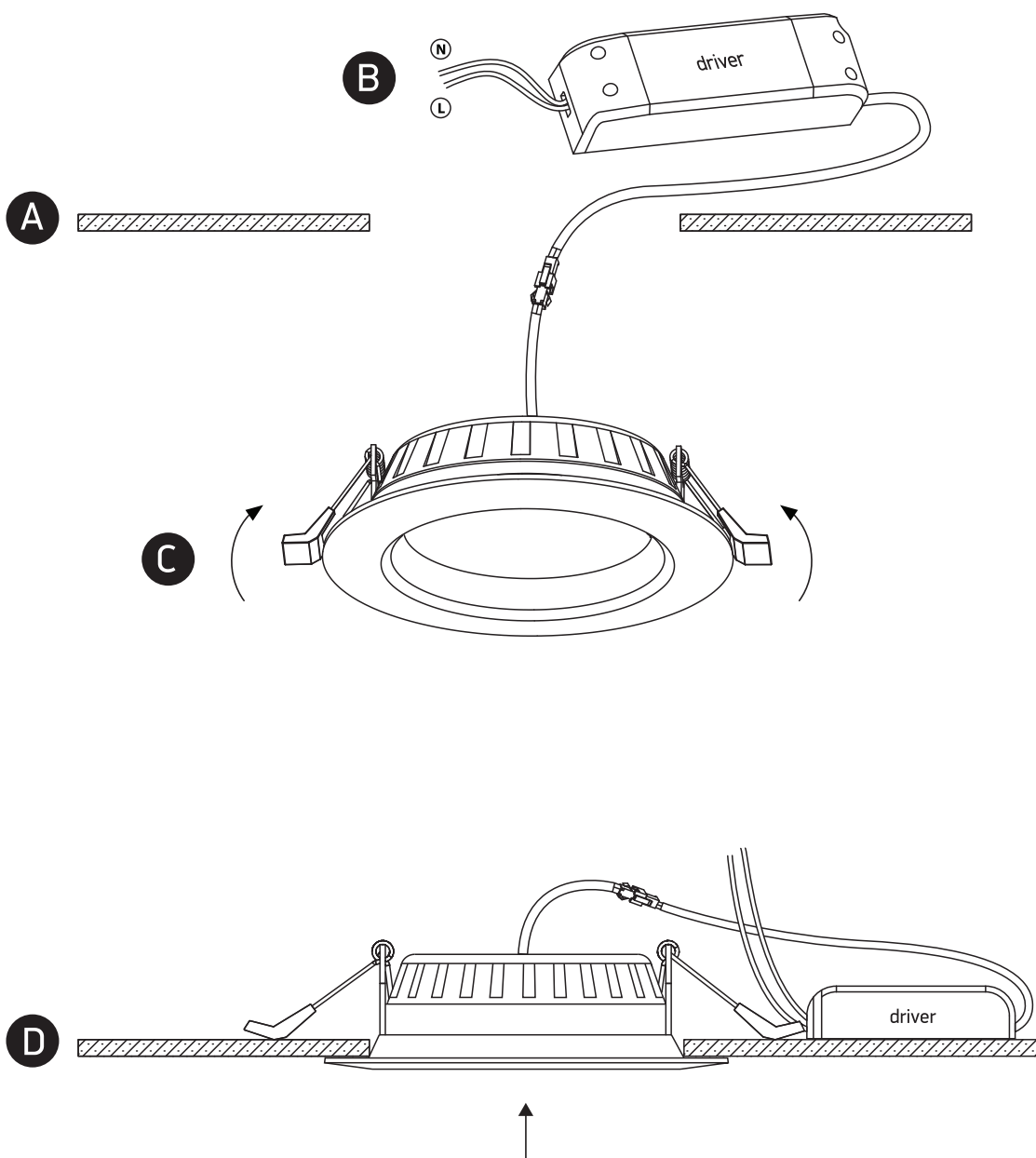

Warnings:

1. Make sure that the product is installed properly before connecting to electricity.
2. Do not cover the fitting.
3. Maintenance and installation should only be carried out by a professional electrician.